

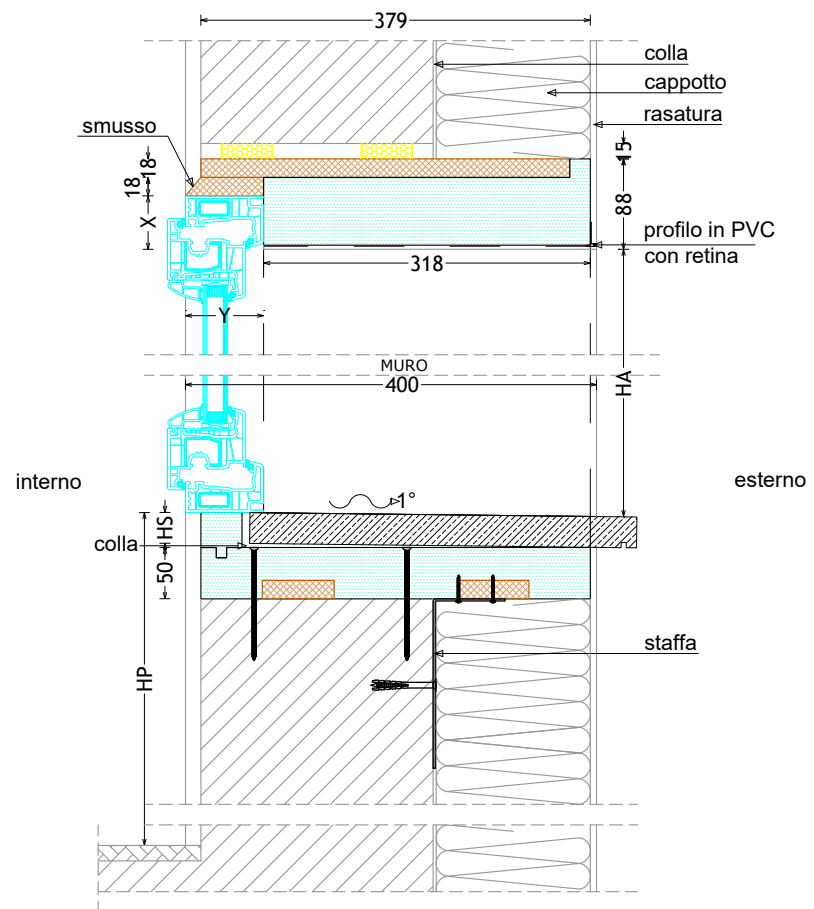

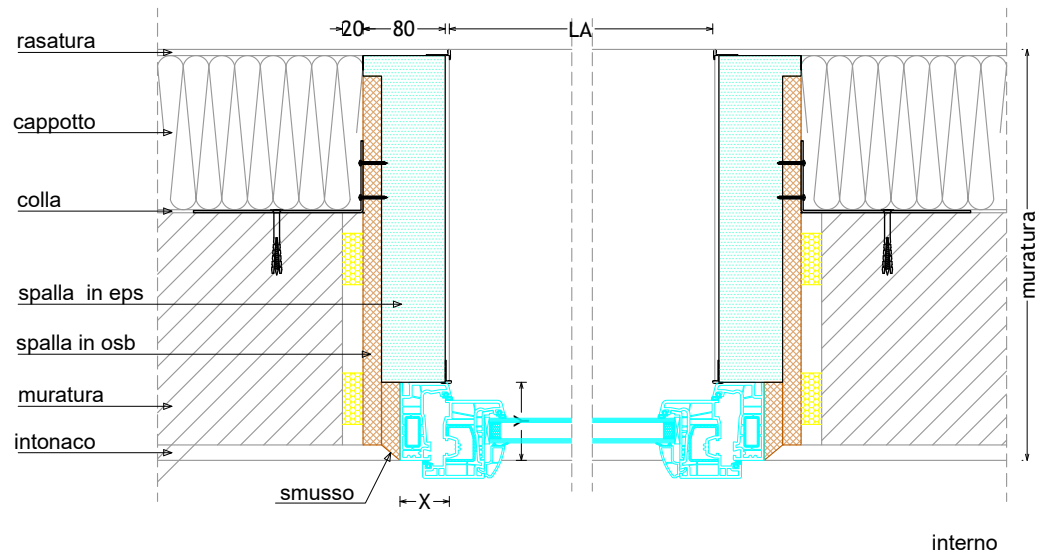

SEZIONE VERTICALE



SEZIONE ORIZZONTALE



X = battuta laterale serramento
 Y = profondità serramento
 HP = altezza parapetto
 HS = spessore soglia
 LA = larghezza architettonica
 HA = altezza architettonica

-  Schiuma poliuretanic
-  Pannello osb
-  Pannello EPS
-  Soglia

	OGGETTO:		Sezione verticale e orizzontale muratura monoblocco V-Block	
			per finestra	
DISEGNATORE:	SCALA:	DISEGNO N°:	DATA:	PRODOTTO:
	1:5			V - BLOCK S
La proprietà e i diritti di questo disegno sono riservati a termine di legge.				